

REVISIONS		DATE	APPROVED
ZONE	REV.	DESCRIPTION	

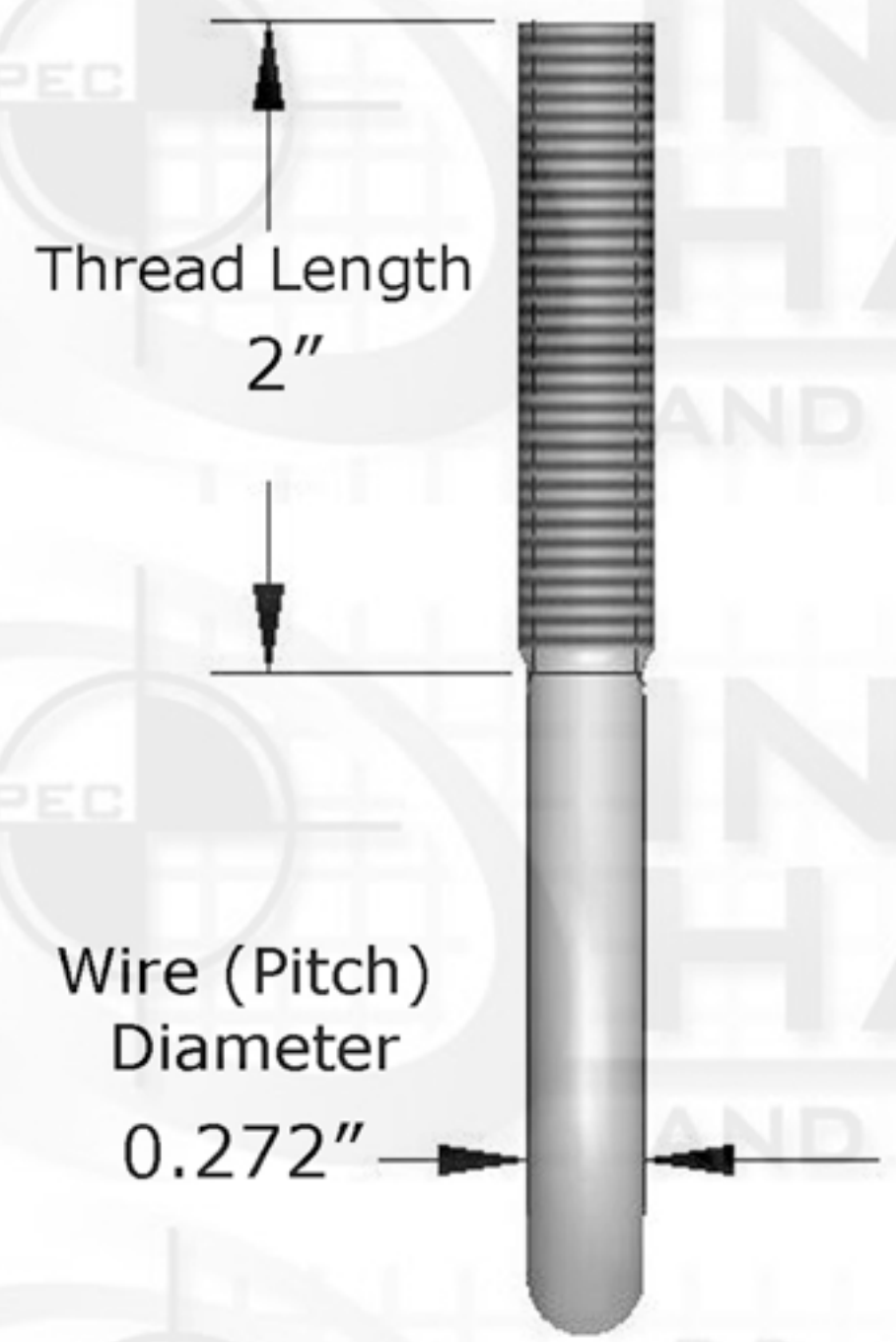
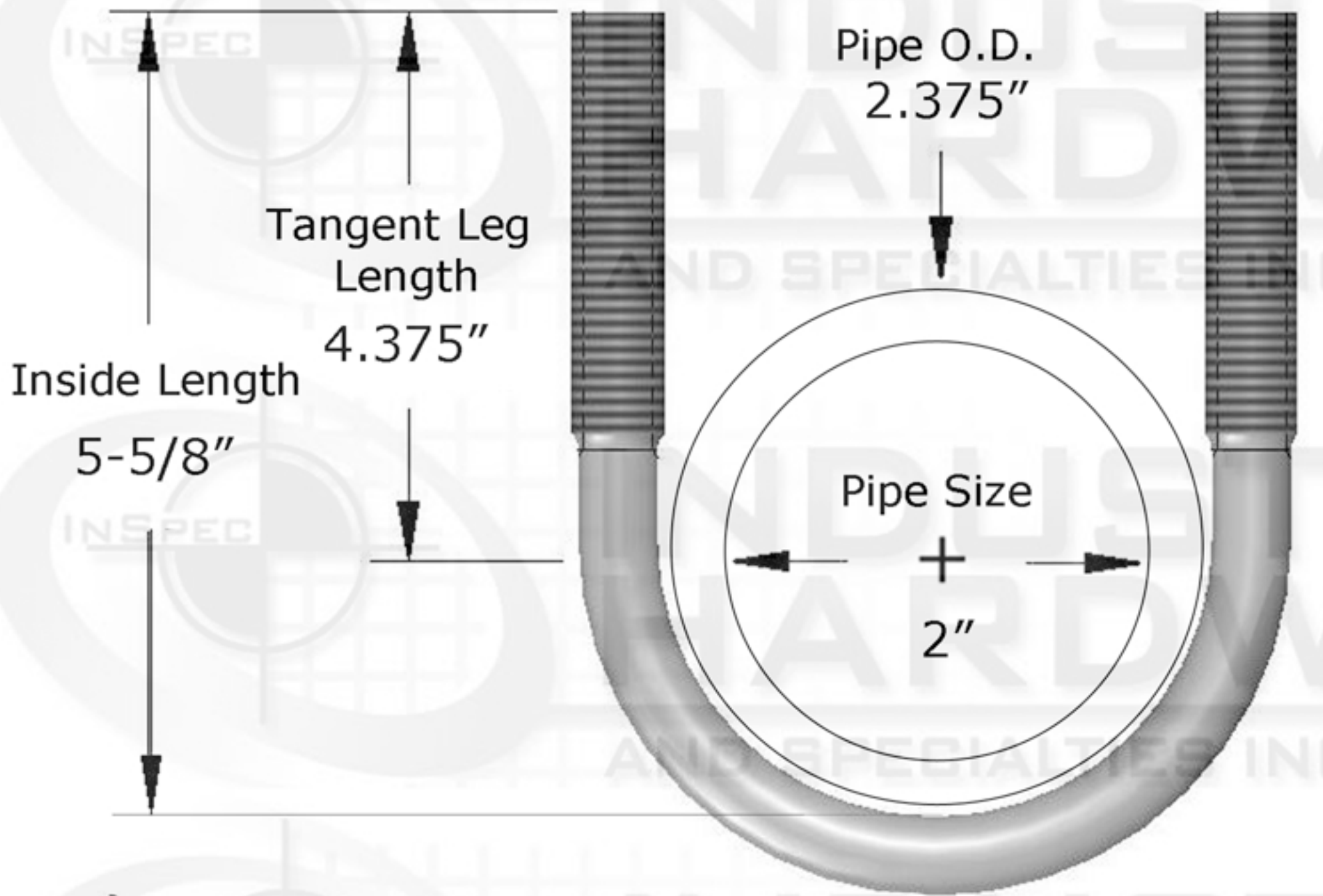
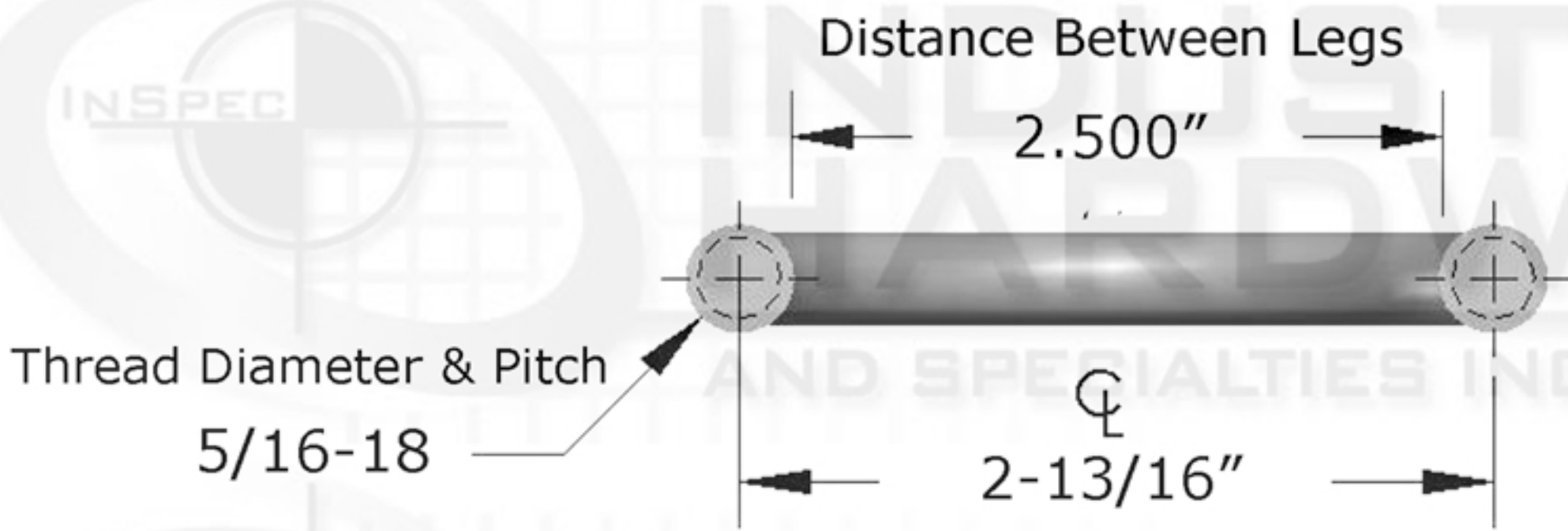

PROPRIETARY AND CONFIDENTIAL

THIS DRAWING AND IT'S CONTENT IS THE SOLE PROPERTY OF INDUSTRIAL HARDWARE & SPECIALTIES,INC.. ANY REPRODUCTION IN PART OR AS A WHOLE WITHOUT THE WRITTEN PERMISSION OF INDUSTRIAL HARDWARE & SPECIALTIES,INC. IS STRICTLY PROHIBITED.

DIMENSIONS ARE IN INCHES TOLERANCES: FRACTIONAL $\pm 1/64$ " ANGULAR: MACH $\pm 1^\circ$ BEND $\pm 1^\circ$ TWO PLACE DECIMAL $\pm .01$ " THREE PLACE DECIMAL $\pm .005$ " CONCENTRICITY T.I.R. = .005"	
MATERIAL FINISH Stainless Steel Type 304	
PART NUMBER 78A-UBH31-0200L-304	
NEXT ASSY	USED ON
APPLICATION	DO NOT SCALE DRAWING

	NAME	DATE
DRAWN		
CHECKED		
ENG APPR.		
MFG APPR.		
Q.A.		
COMMENTS:		

INDUSTRIAL HARDWARE
AND SPECIALTIES INCORPORATED

17-B KENTUCKY AVENUE
PATERSON, NEW JERSEY 07503
TEL: 973-684-4010 FAX: 973-684-3095
email: TechSupport@industrialhardware.com
www.industrialhardware.com

SIZE A	DWG. NO.	REV.
SCALE: 1:8	WEIGHT: 0.22	SHEET 1 OF 1