

2

1

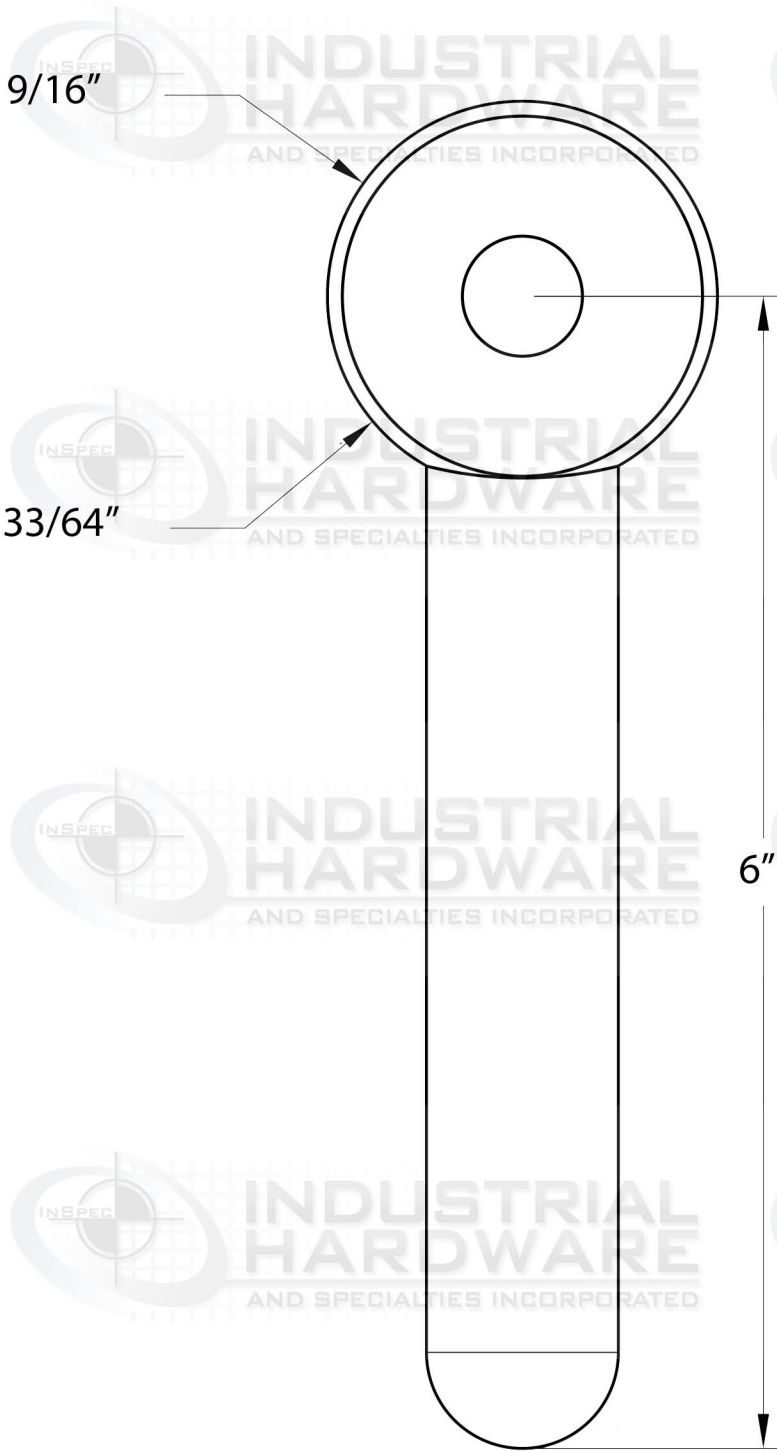

SCALE 1:1

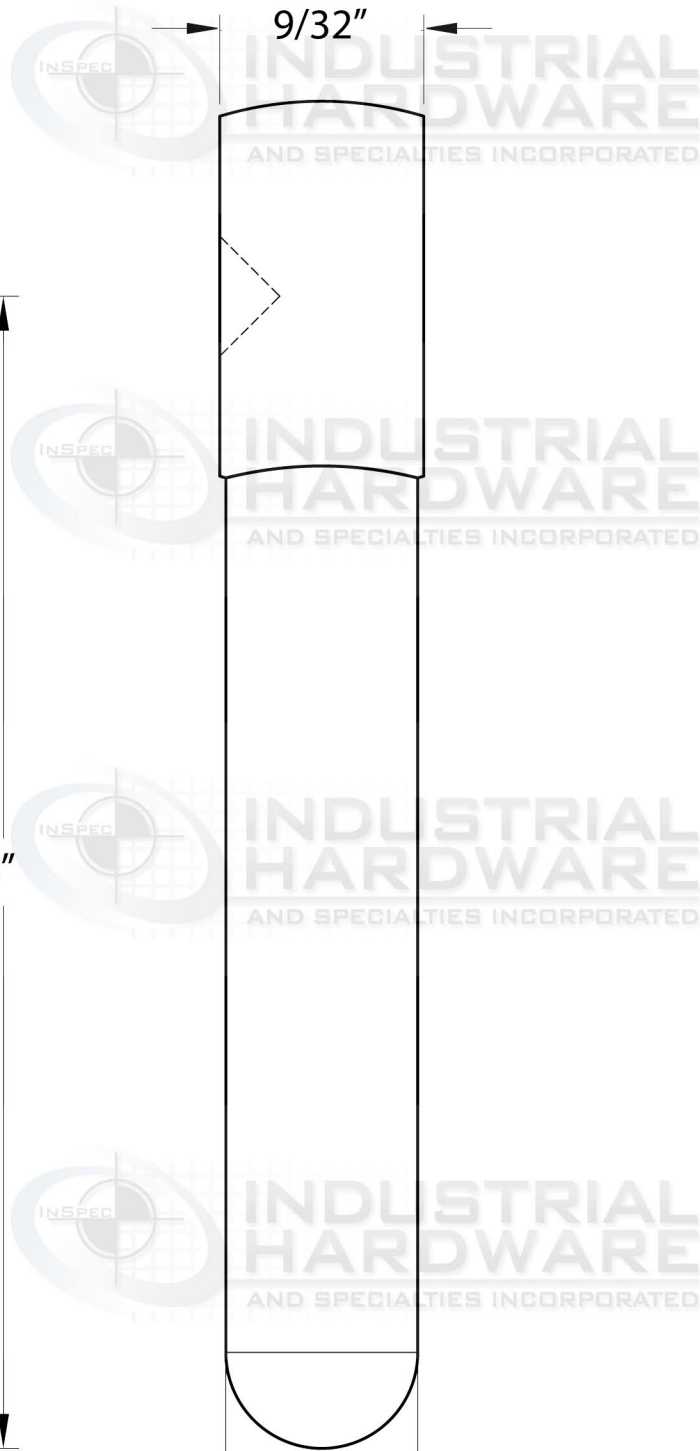

SCALE 1:1

UNLESS OTHERWISE SPECIFIED, DIMENSIONS ARE IN INCHES

.XX = ±.0-
.XXX = ±.00-
.XXXX = ±.000-
ANGULAR = ±°
FRACTIONAL = ±

SURFACE FINISH

DO NOT SCALE DRAWING

BREAK ALL SHARP EDGES AND REMOVE BURRS

THIRD ANGLE PROJECTION



	NAME	DATE
DRAWN	SANE FRIEND	07/22/2020
CHECKED		
APPROVED		

MATERIAL	FINISH
Stainless Steel Type 316	Self-Colored



INDUSTRIAL HARDWARE & SPECIALTIES, INC.
17-B KENTUCKY AVE PATERSON NJ 07503
973-684-4010 | INDUSTRIALHARDWARE.COM

TITLE		
SIZE	DWG NO.	
A	59A-1E-316SS	
SCALE	WEIGHT	SHEET
1:4	0.14	1 of 1

2

1

B

B

A

A