

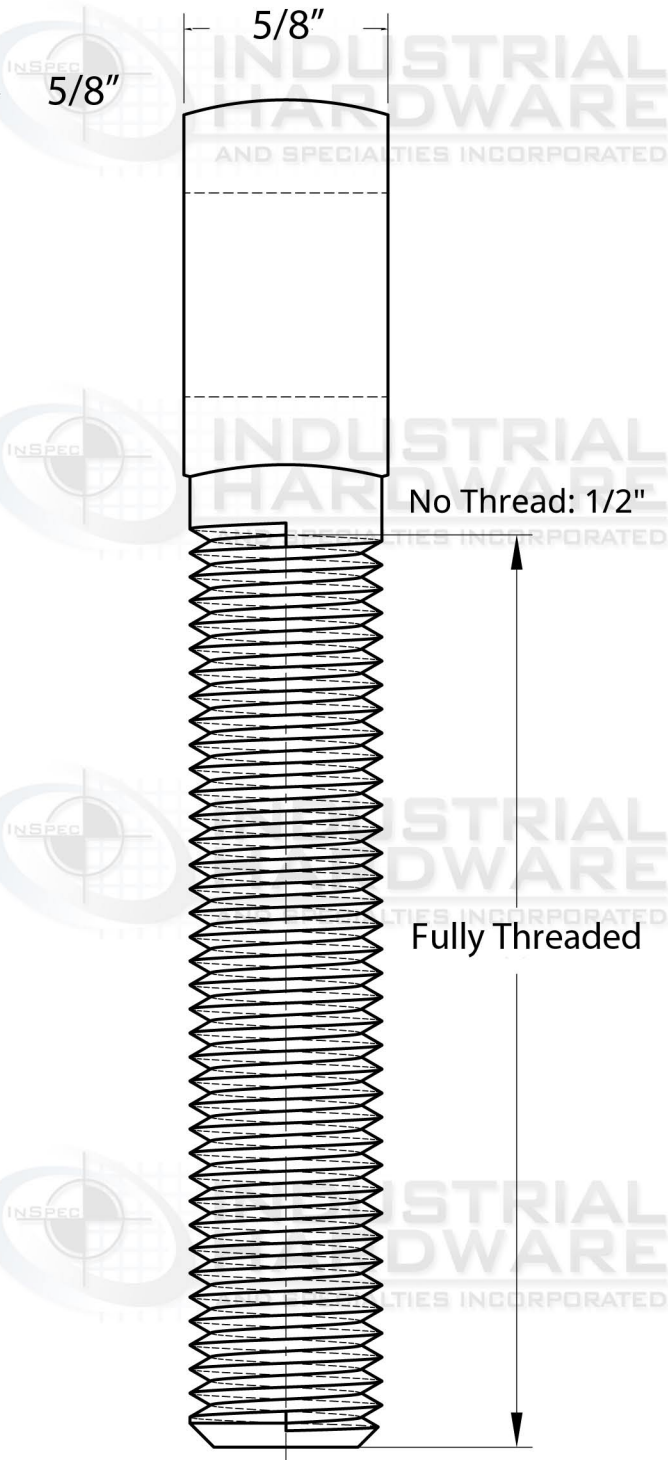

2

1

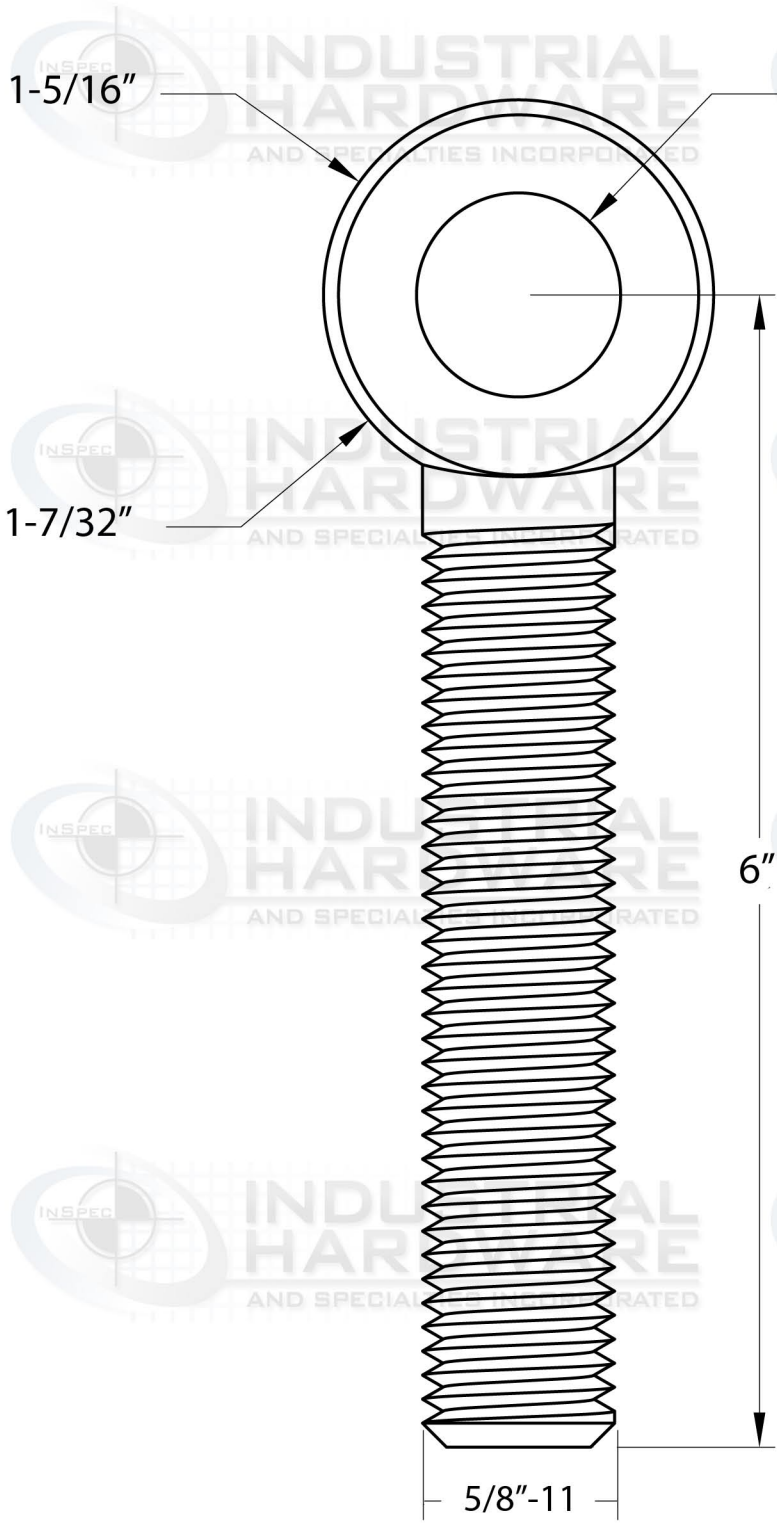

SCALE 1:1

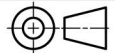
SCALE 1:1

UNLESS OTHERWISE SPECIFIED, DIMENSIONS ARE IN INCHES .XX = ±.0- .XXX = ±.00- .XXXX = ±.000- SURFACE FINISH <input checked="" type="checkbox"/> DO NOT SCALE DRAWING BREAK ALL SHARP EDGES AND REMOVE BURRS THIRD ANGLE PROJECTION 		NAME	DATE	 INDUSTRIAL HARDWARE & SPECIALTIES, INC. 17-B KENTUCKY AVE PATERSON NJ 07503 973-684-4010 INDUSTRIALHARDWARE.COM	
	DRAWN	SANE FRIEND	07/22/2020		TITLE
	CHECKED				SIZE
	APPROVED				DWG NO.
	MATERIAL	FINISH		REV.	
	Stainless Steel	Self-Colored			
	Type 304		SCALE	1 of 1	
			1:4		
			WEIGHT		
			0.55		
			SHEET		
			1 of 1		

2

1