

2

1

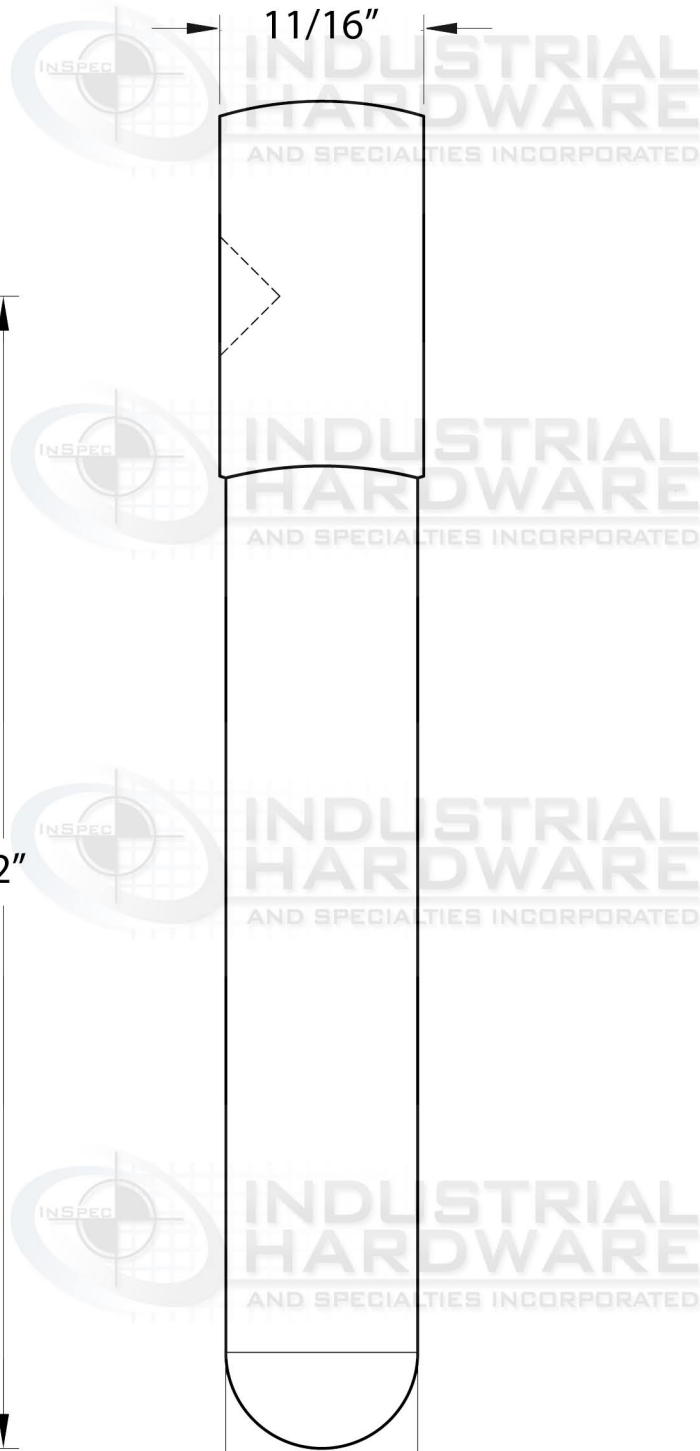
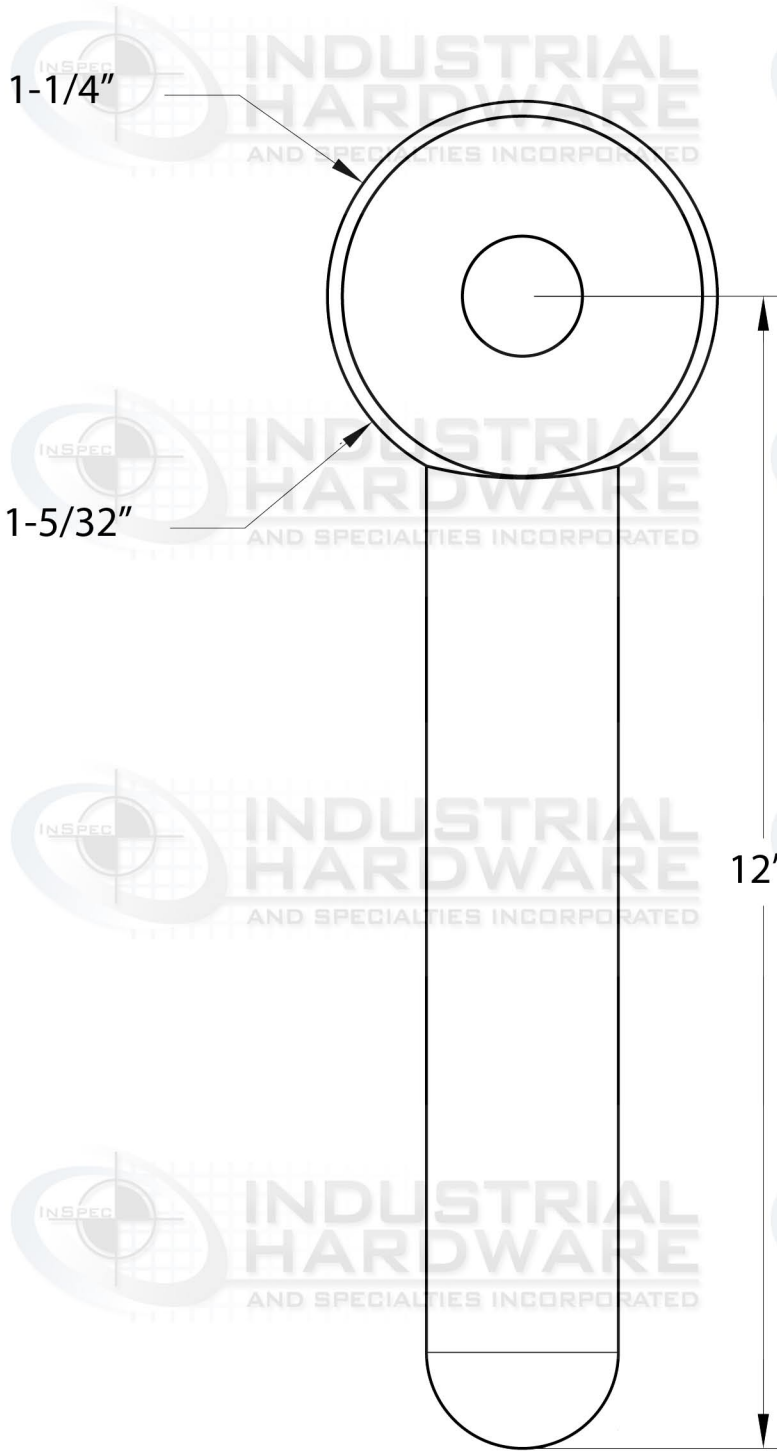

SCALE 1:1

SCALE 1:1

UNLESS OTHERWISE SPECIFIED, DIMENSIONS ARE IN INCHES

.XX = ±.0-
.XXX = ±.00-
.XXXX = ±.000-
ANGULAR = ±°
FRACTIONAL = ±

SURFACE FINISH

DO NOT SCALE DRAWING

BREAK ALL SHARP EDGES AND REMOVE BURRS

THIRD ANGLE PROJECTION



NAME DATE

DRAWN SANE FRIEND 07/22/2020

CHECKED

APPROVED



INDUSTRIAL HARDWARE & SPECIALTIES, INC.
17-B KENTUCKY AVE PATERSON NJ 07503
973-684-4010 | INDUSTRIALHARDWARE.COM

TITLE

SIZE A

DWG NO.

59A-6J-316SS

REV.

SCALE 1:4

WEIGHT 1.25

SHEET 1 of 1

2

1

B

B

A

A