

2

1

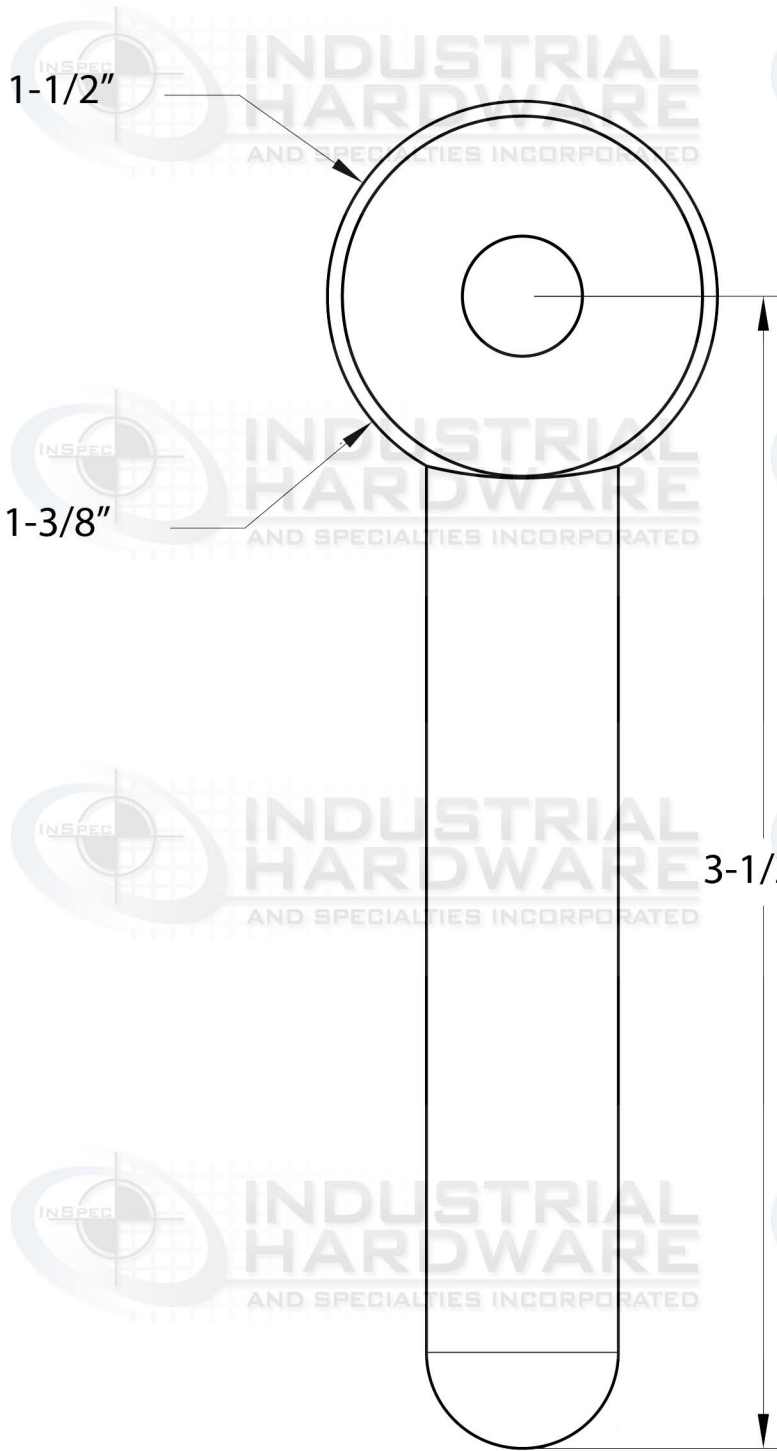

SCALE 1:1

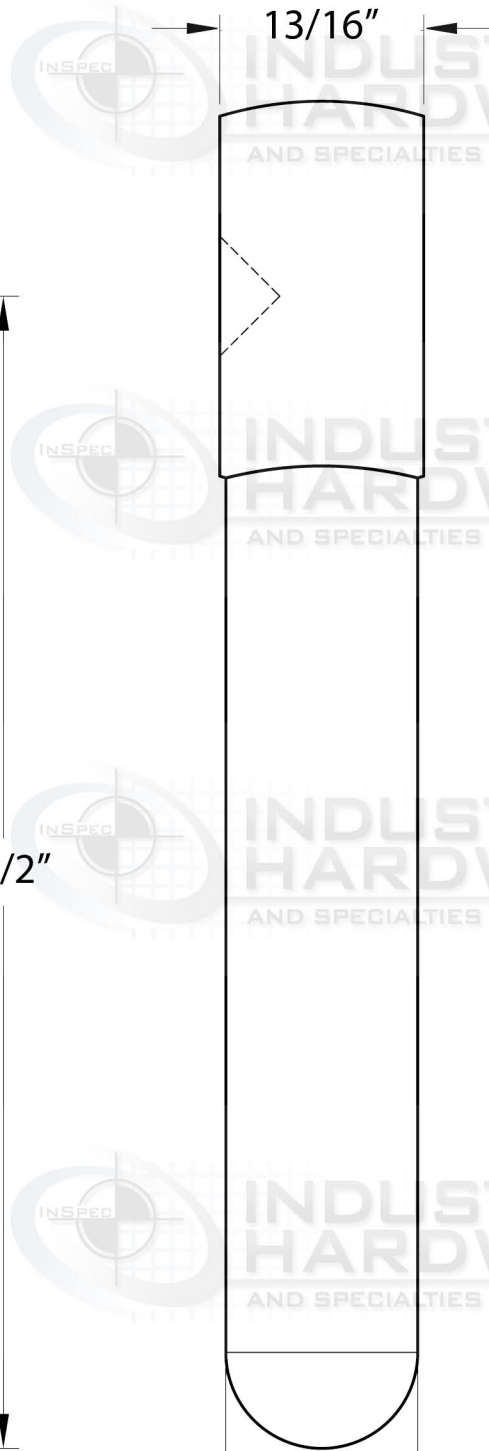

SCALE 1:1

UNLESS OTHERWISE SPECIFIED, DIMENSIONS ARE IN INCHES

.XX = ±.0-
.XXX = ±.00-
.XXXX = ±.000-
ANGULAR = ±°
FRACTIONAL = ±

SURFACE FINISH

DO NOT SCALE DRAWING

BREAK ALL SHARP EDGES AND REMOVE BURRS

THIRD ANGLE PROJECTION

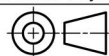

NAME	DATE
DRAWN	SANE FRIEND 07/22/2020
CHECKED	
APPROVED	

MATERIAL	FINISH
Carbon Steel C1030/1035	Self-Colored



INDUSTRIAL HARDWARE & SPECIALTIES, INC.
17-B KENTUCKY AVE PATERSON NJ 07503
973-684-4010 | INDUSTRIALHARDWARE.COM

TITLE			
SIZE	DWG NO.		
A	59A-7A		
SCALE	WEIGHT	SHEET	REV.
1:4	0.75	1 of 1	

2

1