

ROOF HATCH - Diamond Series™ - ROOF HATCH, DIAMOND SERIES 30 X 96 (RHG-3) | GALV STEEL, WHITE TEXTURED

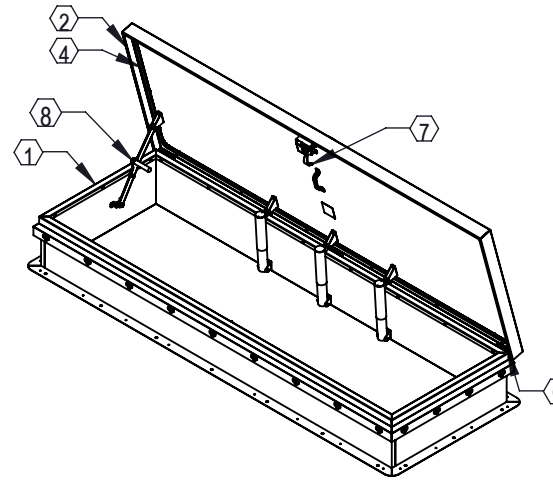
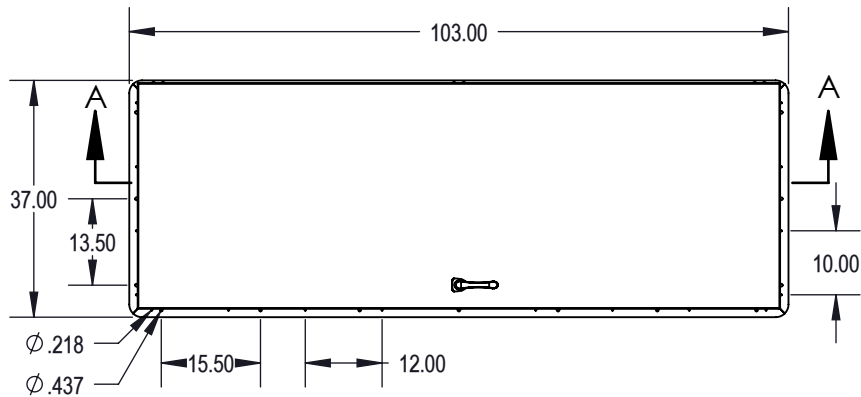

SPECIFICATIONS:

1. Curb: 14 gauge galvanized steel single wall curb and counterflashing with Diamond Grip.
2. Cover: 14 gauge galvanized steel formed, welded cover with 22 gauge liner, tested to support a live load of 40psf.
3. Finish: White, textured powder coat paint.
4. Gasket: Continuous, weatherproof EPDM sponge rubber adhesive-backed seal.
5. Insulation: 1" polyisocyanurate in curb and cover with thermal resistance R-6.
6. Spring: Counterbalanced compression springs contained in clear zinc-plated steel cylinders.
7. Latch: Clear zinc-plated steel slam latch with inside and outside handles and padlock hasps. Tested to 50psf wind uplift.
8. Hold Open Arm: Clear zinc-plated automatic locking hold open arm with red vinyl grip for one handed door operation.
9. Hinge: Heavy duty clear zinc-plated steel pintle hinge.

Notes:

For pitched roofs up to 7:12, mount hinge side parallel to slope.
 Door opens 75°
 Clear Opening: 19" X 90"
 Weight: 289lbs

Diamond Series™ is a trademark of ACPG.

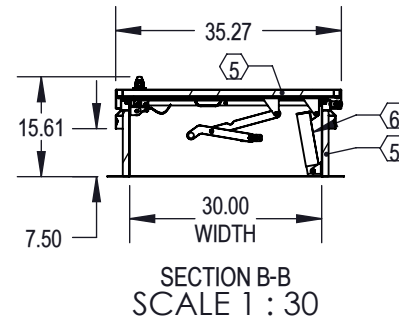
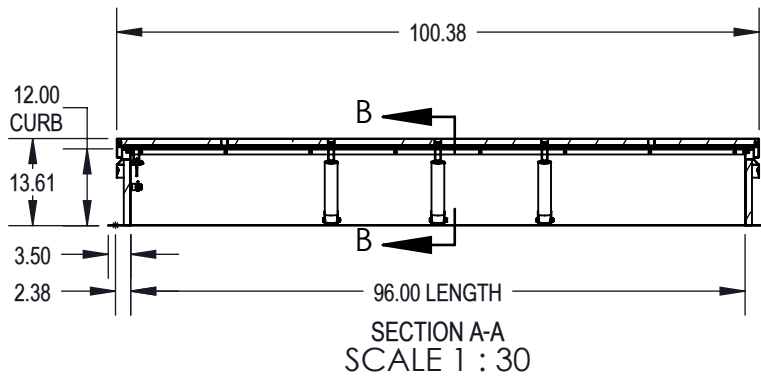

MODEL #: RHDG-3WT



9702 Newton Ave S. Bloomington, MN 55431 | 10 Locations Nationwide

800-554-6077 952-835-2218 sales@activarcpg.com www.activarcpg.com

Distributor:		Project:	
Contractor:		Approved By:	
Date:	Quantity:	Architect:	
Scale: 1:16	Pages: 1 OF 1	Drawing #:	RHDG-3WT-SUBMITTAL_A