

ZONE		REV.	REVISIONS DESCRIPTION	DATE	APPROVED

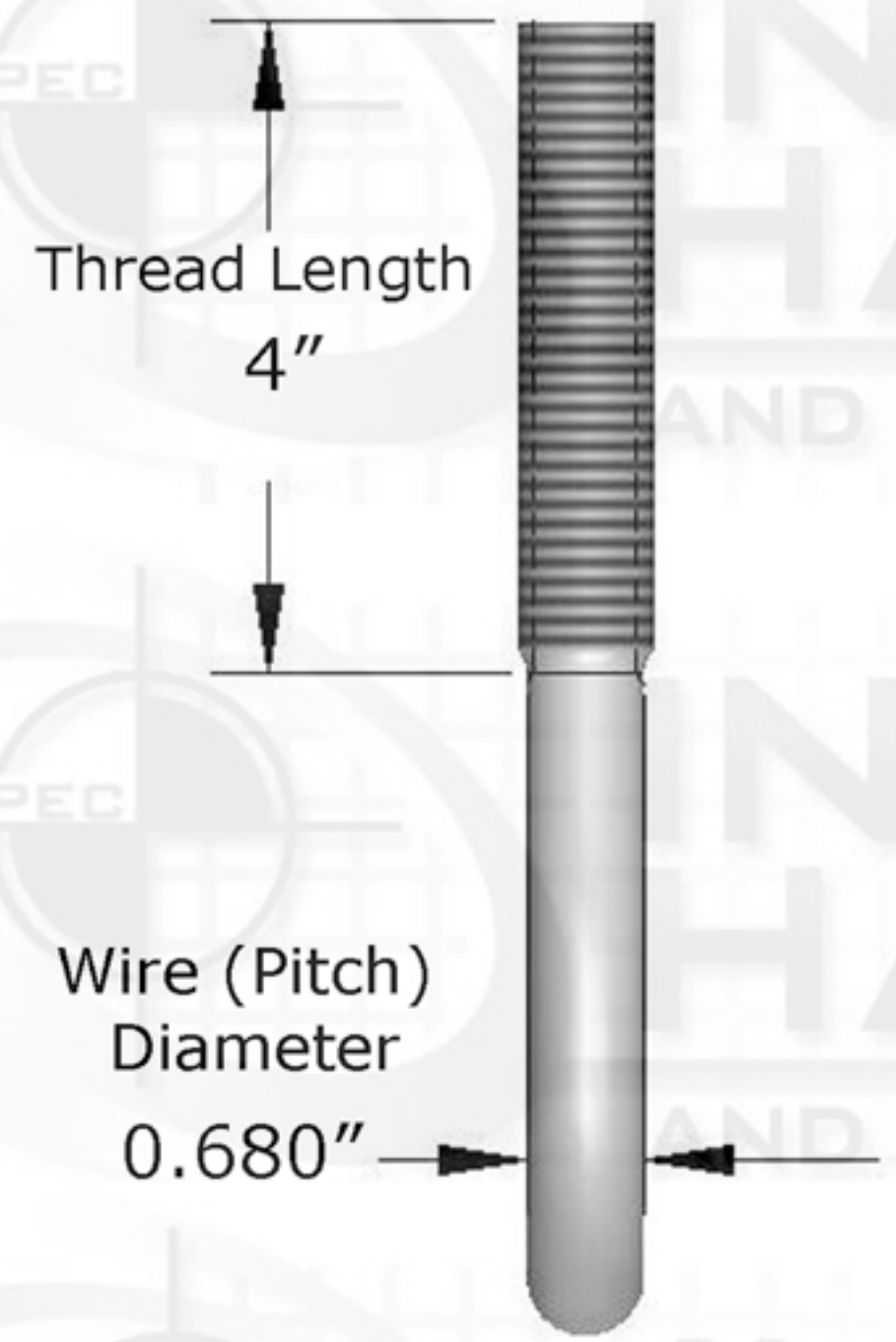
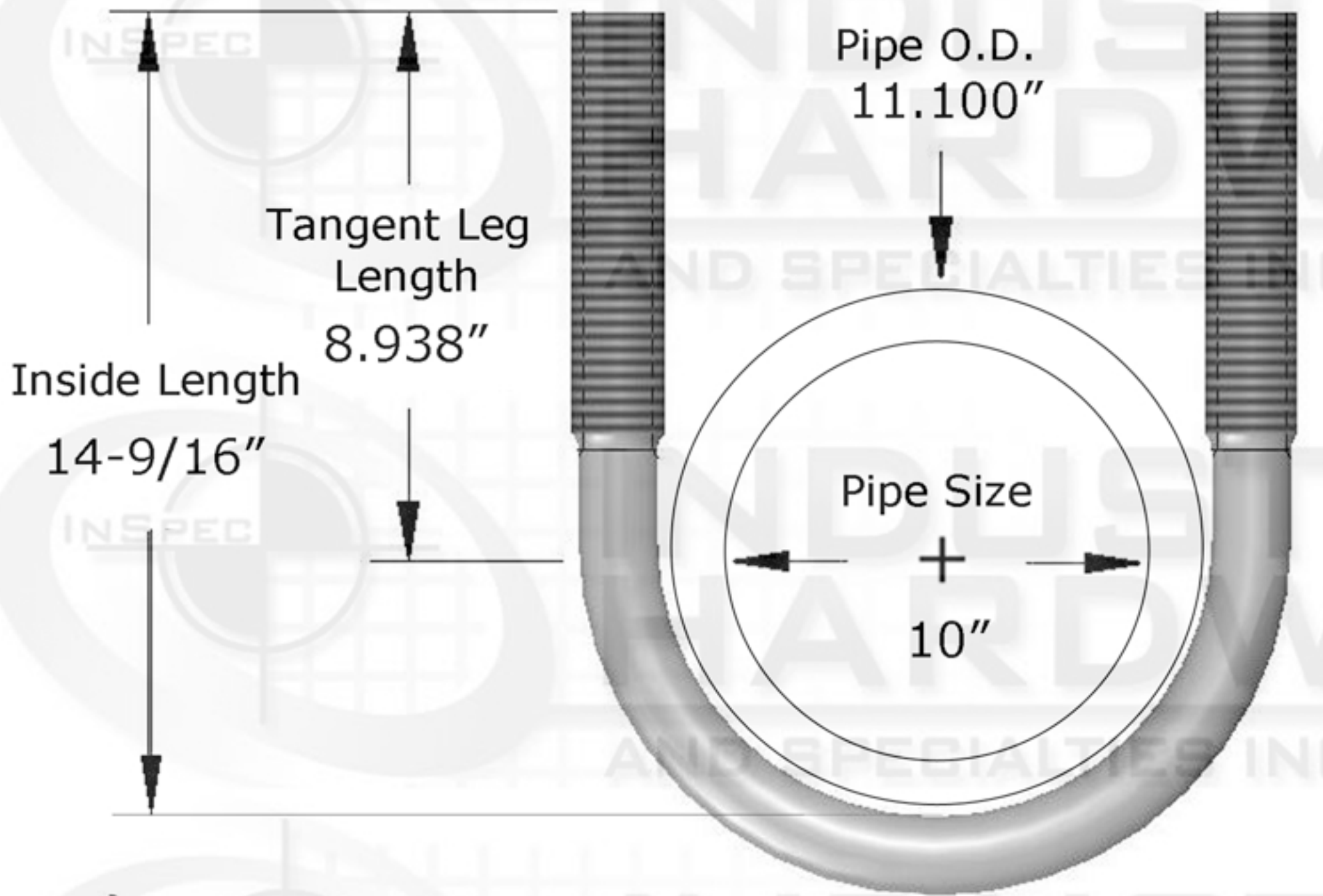
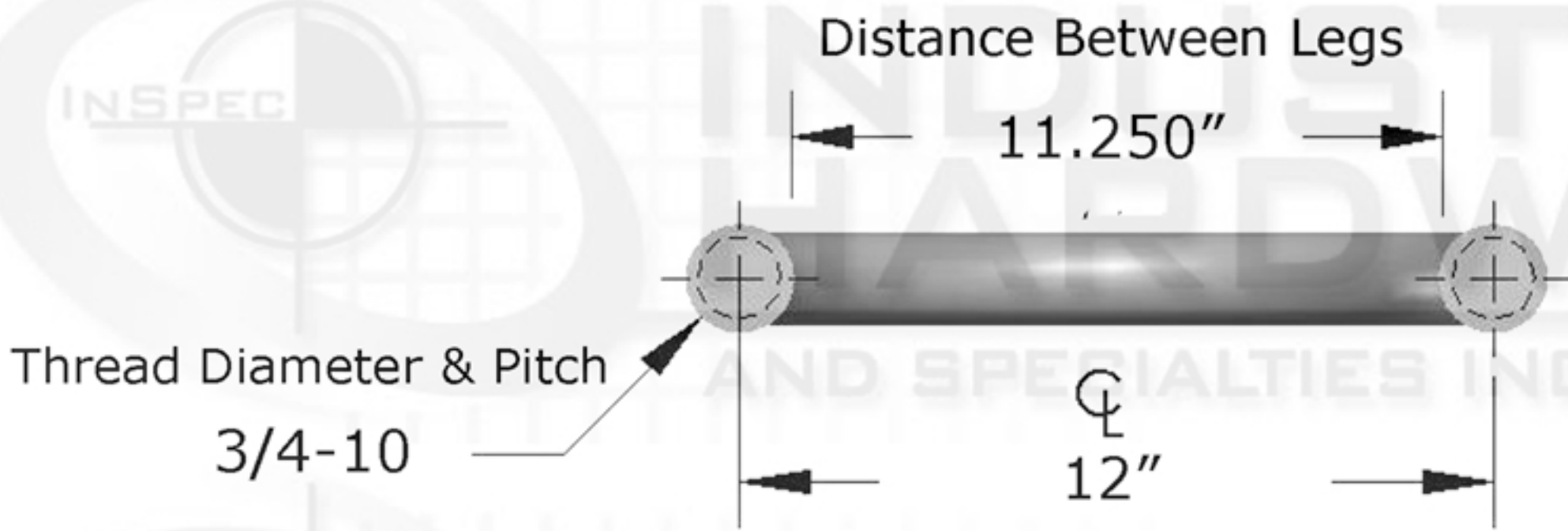

**PROPRIETARY AND CONFIDENTIAL**

THIS DRAWING AND IT'S CONTENT IS THE SOLE PROPERTY OF INDUSTRIAL HARDWARE & SPECIALTIES,INC.. ANY REPRODUCTION IN PART OR AS A WHOLE WITHOUT THE WRITTEN PERMISSION OF INDUSTRIAL HARDWARE & SPECIALTIES,INC. IS STRICTLY PROHIBITED.

DIMENSIONS ARE IN INCHES TOLERANCES: FRACTIONAL ± 1/64" ANGULAR: MACH ± 1° BEND ± 1° TWO PLACE DECIMAL ± .01" THREE PLACE DECIMAL ± .005" CONCENTRICITY T.I.R. = .005"		NAME	DATE
DRAWN			
CHECKED			
ENG APPR.			
MFG APPR.			
Q.A.			
MATERIAL FINISH Hot Dip Galvanized		COMMENTS:	
PART NUMBER 78A-UBD-1000-HG			
NEXT ASSY	USED ON		
APPLICATION		DO NOT SCALE DRAWING	

**INDUSTRIAL HARDWARE**  
AND SPECIALTIES INCORPORATED

17-B KENTUCKY AVENUE  
PATERSON, NEW JERSEY 07503  
TEL: 973-684-4010 FAX: 973-684-3095  
email: TechSupport@industrialhardware.com  
www.industrialhardware.com

SIZE	DWG. NO.	REV.
A		

SCALE: 1:8    WEIGHT: 3.82    SHEET 1 OF 1