

REVISIONS		DATE	APPROVED
ZONE	REV.	DESCRIPTION	

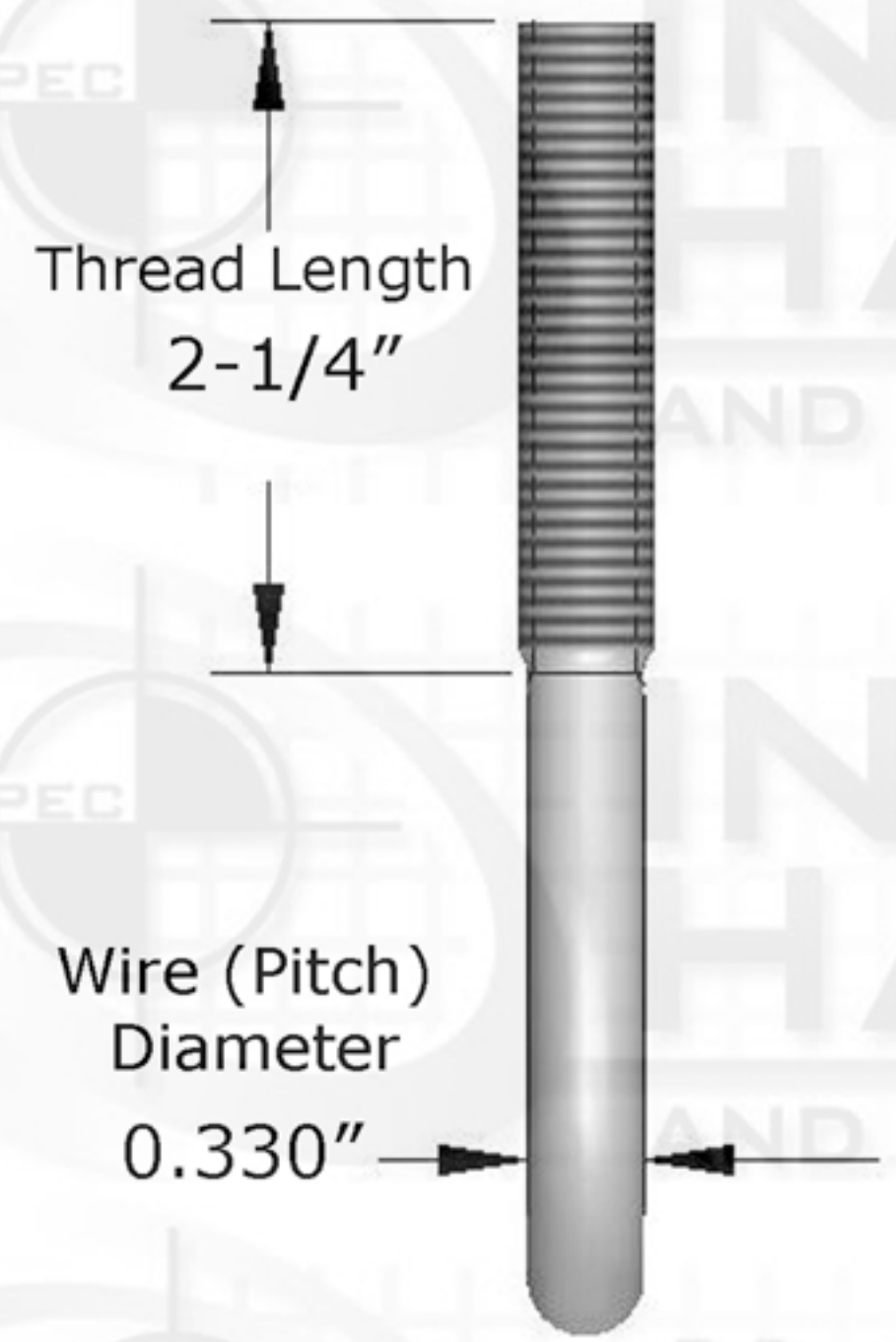
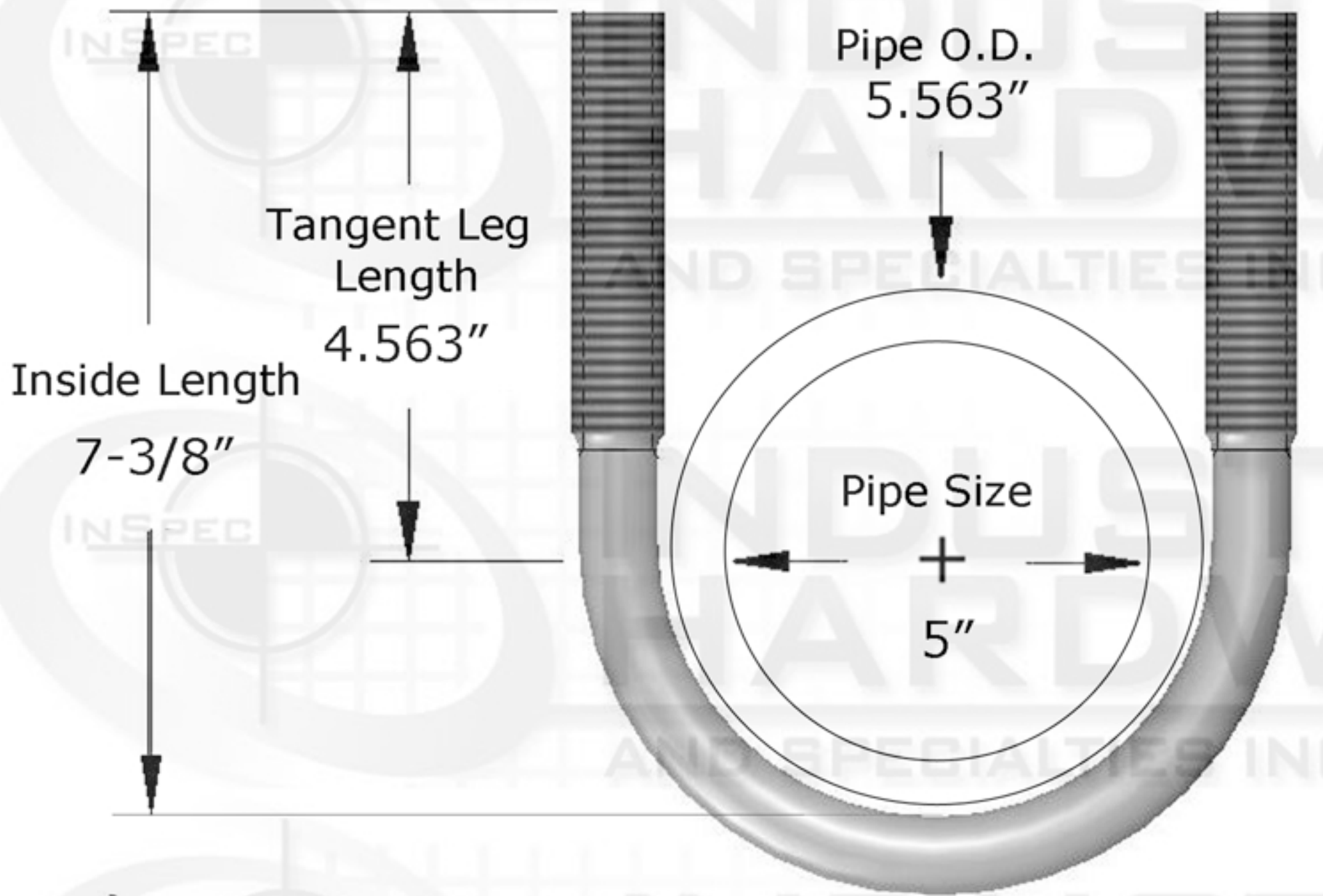
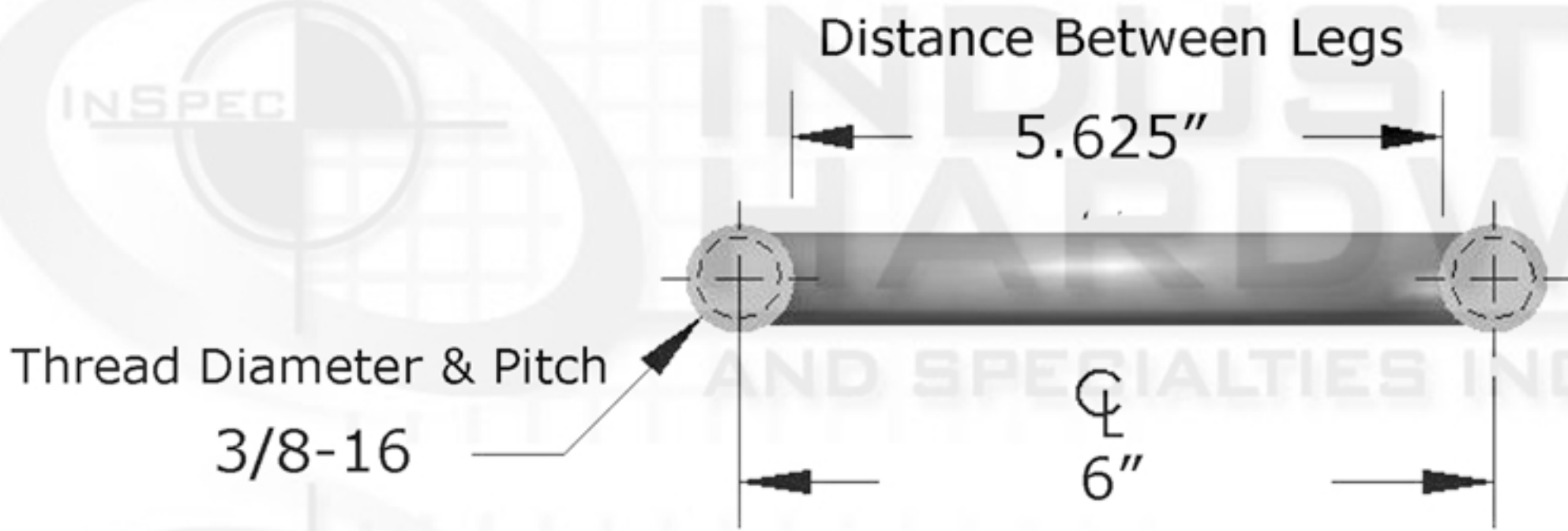

PROPRIETARY AND CONFIDENTIAL

THIS DRAWING AND IT'S CONTENT IS THE SOLE PROPERTY OF INDUSTRIAL HARDWARE & SPECIALTIES,INC.. ANY REPRODUCTION IN PART OR AS A WHOLE WITHOUT THE WRITTEN PERMISSION OF INDUSTRIAL HARDWARE & SPECIALTIES,INC. IS STRICTLY PROHIBITED.

DIMENSIONS ARE IN INCHES TOLERANCES: FRACTIONAL ± 1/64" ANGULAR: MACH ± 1° BEND ± 1° TWO PLACE DECIMAL ± .01" THREE PLACE DECIMAL ± .005" CONCENTRICITY T.I.R. = .005"		NAME	DATE
NEXT ASSY	USED ON	DRAWN	
		CHECKED	
		ENG APPR.	
		MFG APPR.	
		Q.A.	
APPLICATION	DO NOT SCALE DRAWING	COMMENTS:	

INDUSTRIAL HARDWARE
AND SPECIALTIES INCORPORATED

17-B KENTUCKY AVENUE
PATERSON, NEW JERSEY 07503
TEL: 973-684-4010 FAX: 973-684-3095
email: TechSupport@industrialhardware.com
www.industrialhardware.com

SIZE	DWG. NO.	REV.
A		

SCALE: 1:8 WEIGHT: 0.47 SHEET 1 OF 1