

CONTENTS	9110	9130	
1. TRACK (9101)	1	1	
2. CARRIER	2 (9102)	2 (9105)	
3. DOOR MOUNT PLATE	2	2	
4. FLOOR GUIDE (9115)	1	1	
5. #10 X 1-1/2" PPHS	20	20	
6. #6 X 7/8" FPHS	4	4	
7. #12 X 1-1/4" PPHS	8	8	
8. RUBBER BUMPER (9881) (sold separately)	1	1	
9. PULL (Sold separately)	1	1	

1 PREPARE OPENING

OPENING HEIGHT MAX = DOOR HEIGHT + 3-1/2"
 OPENING HEIGHT MIN = DOOR HEIGHT + 4-1/4"

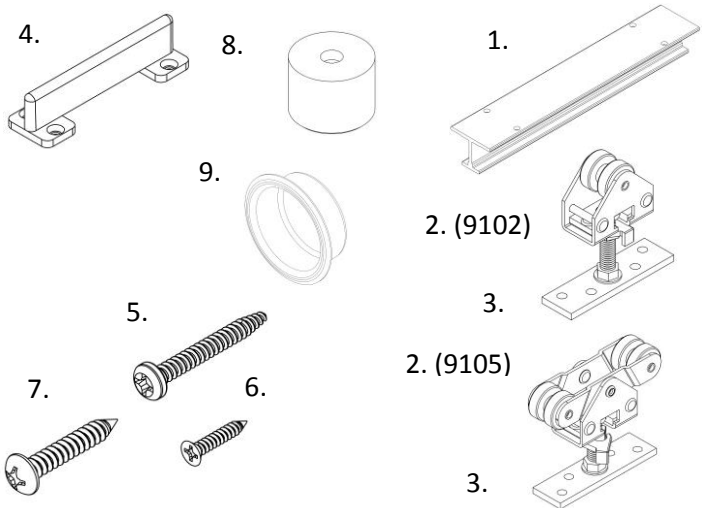
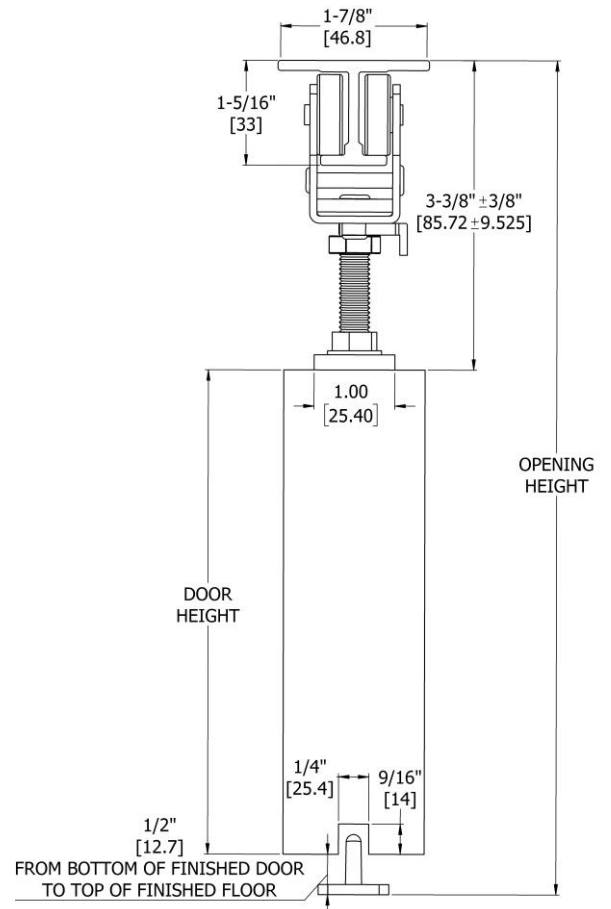
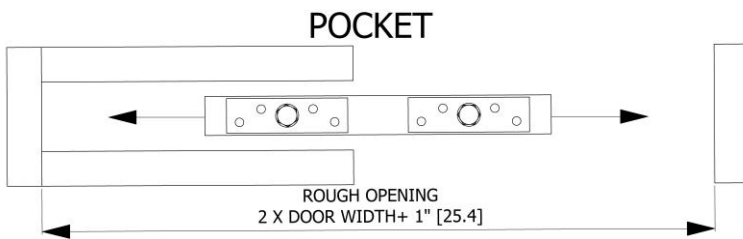

2 INSTALL TRACK AND HANGERS

- Center track in opening and secure with (#10x1-1/2") screws
- Leave a 1" gap between opening end of track and door frame to allow for removal of carriers
- Center quick release plates on door thickness
- Mount pocket plate edge 3/4" from near pocket door edge
- Mount opening plate edge 1-1/2" from opening door edge
- Secure Carriers onto door with (#12 x 1-1/4") screws

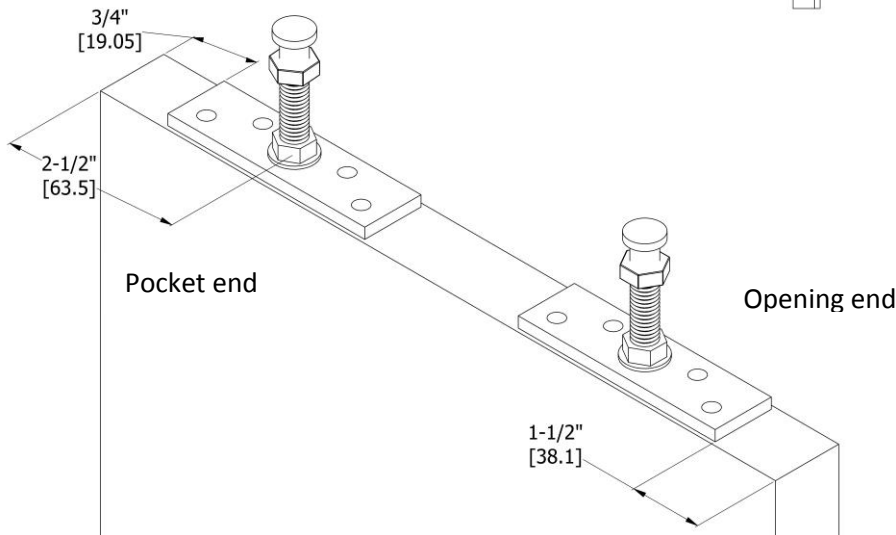
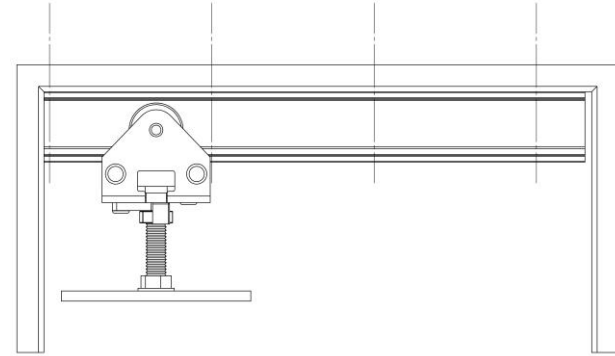

3 HANG DOORS

- Cut a kerf 1/4" X 9/16" deep in bottom of door
- Install door guide directly under track and as far into pocket as practical using (#6 X 7/8") screws
- Open quick release latches on brackets
- Slide door onto carrier and close hatch

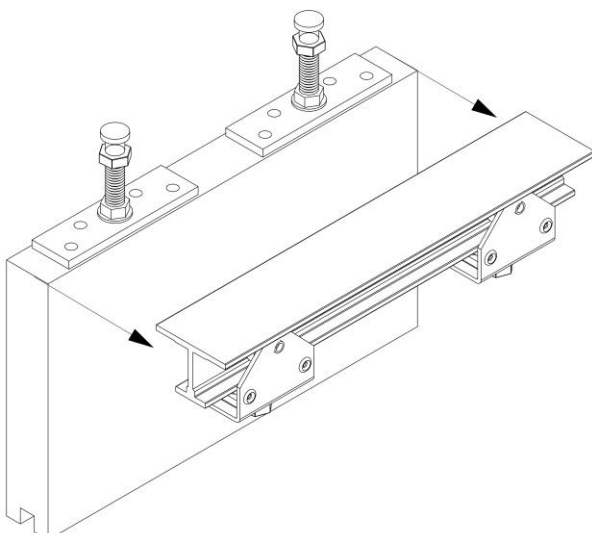

4 ADJUST AND FINISH

- Adjust carriers so door is square with frame
- Drill appropriate dimensioned hole to mount door pull (optional)
- Install stops (optional)

